



Anna Martynenko  
Portfolio

[annamartynenko.ru](http://annamartynenko.ru)

## Bio

Anna Martynenko (b. 1985, the USSR). Lives and works in St. Petersburg. Graduated from the Department of Scenography (Set Design) of the St. Petersburg State Theatre Arts Academy, the School for Young Artists of PRO ARTE Foundation and the New Media Lab of the Alexandrinsky Theatre. Since 2014 she has been working as a media artist, creating objects, installations, site-specific and public art projects. She exhibited at the Sound Museum, FFTN Gallery, Nepokorenye 17 studio and participated in group exhibitions, fairs and festivals.

## Artist Statement

By contesting the division between the realm of memory and the realm of experience, she makes work that deals with the documentation of events and the question of how they can be presented.

Her collected, altered and own works are being confronted as aesthetically resilient, thematically interrelated material for memory and observation.

In a search for new methods to 'read the city', she focuses on the idea of 'public space' and more specifically on contact with architecture and basic living elements. Energy (wind, light, water), space and landscape are examined in less obvious ways.

# CV

## Education:

- 2018 – School of Young Artist, Pro Arte Foundation
- 2016–2017 – New Media Lab, of the Alexandrinsky Theater
- 2013–2015 – performance design, master's degree, St. Petersburg State Theatre Arts Academy
- 2007–2012 – theater production designer, St. Petersburg State Theatre Arts Academy

## Personal projects:

- 2020 – “Petersburg and its Surroundings: Sound Cards”, Museum of Sound, St. Petersburg
- 2019 – “Unconquered. The Order of Things”, studio “Nepokorennye, 17”, St. Petersburg
- 2018 – “Opening Angle Is 15”, FFTN gallery, St. Petersburg

## Participation in exhibitions, festivals, projects:

- 2021
  - “Contemplators of the Sun”, Lobachevsky's University, Nizhny Novgorod
- 2020
  - “Waterphone”, Waterfront project, Saint-Petersburg
  - Art-Prospect festival, DK Gaza, Saint-Petersburg
  - Arselectronica festival, Pangardenia project, AIR gallery, Saint-Petersburg
  - “NEMOSKVA IS NOT OVER THE MOUNTAINS”, Central Exhibition Hall “Manezh”, Saint-Petersburg
  - “My Spaces Are Fragile”, Navicula Artis gallery, Saint-Petersburg
- 2019
  - exhibition “Ordinary Things”, DK Gromov, Saint-Petersburg
  - exhibition “Winter Seedlings. Breeder's Choice”, BENUA ART GARDEN, Saint-Petersburg
  - exhibition “New Unknowns”, gallery Luda, Saint-Petersburg
  - exhibition “Impulse”, Sergey Kuryokhin Contemporary Art Center, Saint-Petersburg
  - exposition “New Anthropology”, the museum of science art in Koltushi, Leningradskaya region
  - festival “Epicentroom”, Art center “Pushkinskaya 10”, Saint-Petersburg

- exhibition “MEMENTO VIVERE!”, Navicula Artis gallery, Saint-Petersburg
  - participant of the art camp of the program “100 Cities” of the Agency for Strategic Initiatives, Tyumen
  - participant of the art-camp Beach Urban Week, Sosnovy Bor
  - participant of the BENUA ART GARDEN project, Garden of contemporary art, Saint-Petersburg
  - performance “The Black Staircase. Sum of Movements” as a part of Performa project, Kamennooostrovsky Theater, Big Drama Theatre, Saint-Petersburg
  - participant of the “Waterfront: Neighborhood & Community” project, Saint-Petersburg
  - “Unconquered in Time And Space”, DK Gromov, Saint-Petersburg
  - “LEVELS”, Stepan Razin's factory, Saint-Petersburg
- 2018
- “Shalyapin HMAT”, Chaliapin Museum, Saint-Petersburg
  - Tashkent Biennale of Contemporary Art, Tashkent
  - Artification, Gamma Contemporary Art Festival, Saint-Petersburg
- 2017
- Festival “Night of Light in Gatchina”, Gatchina

## Competitions and residences:

- Winner of the Waterfront Open Project Competition of the Street Art Research Institute and the Danish Cultural Institute in St. Petersburg, 2020
- Laureate of the grant program for St. Petersburg artists working in the field of contemporary art, the Frants Art Foundation, 2020
- Nomination “Art in Public Space” for Sergey Kuryokhin Contemporary Art Award, group projects “City of Birds” and “Museum of Hogweed”, 2020
- Long-list of the Nova Art competition, the “Body Extension” project, 2019
- Resident of the studio “Nepokorennye, 17”, 2019

## Press:

- [Calvert Journal: Curated](#)
- [ARTGUIDE: New anthropology: everyone is interested](#)
- [Paper: Young St. Petersburg Artists Interesting to Follow](#)
- [NTV: Contemporary St. Petersburg art was driven into a hangar](#)
- [ITMO creates space for collaboration between artists and scientists](#)



## “Waterphone”, 2020

Curator Dmitry Pilikin

For Waterfront – an international interdisciplinary project implemented by the Street Art Research Institute and the Danish Cultural Institute in St. Petersburg

“Waterphone” is a special device designed to listen to the splash of water on noisy city embankments. The metal-plastic pipe bends easily, which makes the object transportable. You can carry it around and unfold it as needed to listen to the water. The project draws attention to sound ecology and the problem of noisy waterfront in the city.

<http://en.annamartynenko.ru/waterphone.html>







*Photo by Il'ya Davidov*



## Zine for sound registration "Walk to the Water", 2020

For Waterfront project

Paper, digital printing, ballpoint pen; 140\*210 mm, 12 pages

It is a drawing block with sound observation, made by local residents. Each person highlighted individual sounds from the city noise in order to readjust human perception to the soundscape around. Following instructions, the participants of the walks listened to the road, trees, birds, hatches, as well as to the sound of water splashing against granite embankment.

<http://en.annamartynenko.ru/zine-route.html>

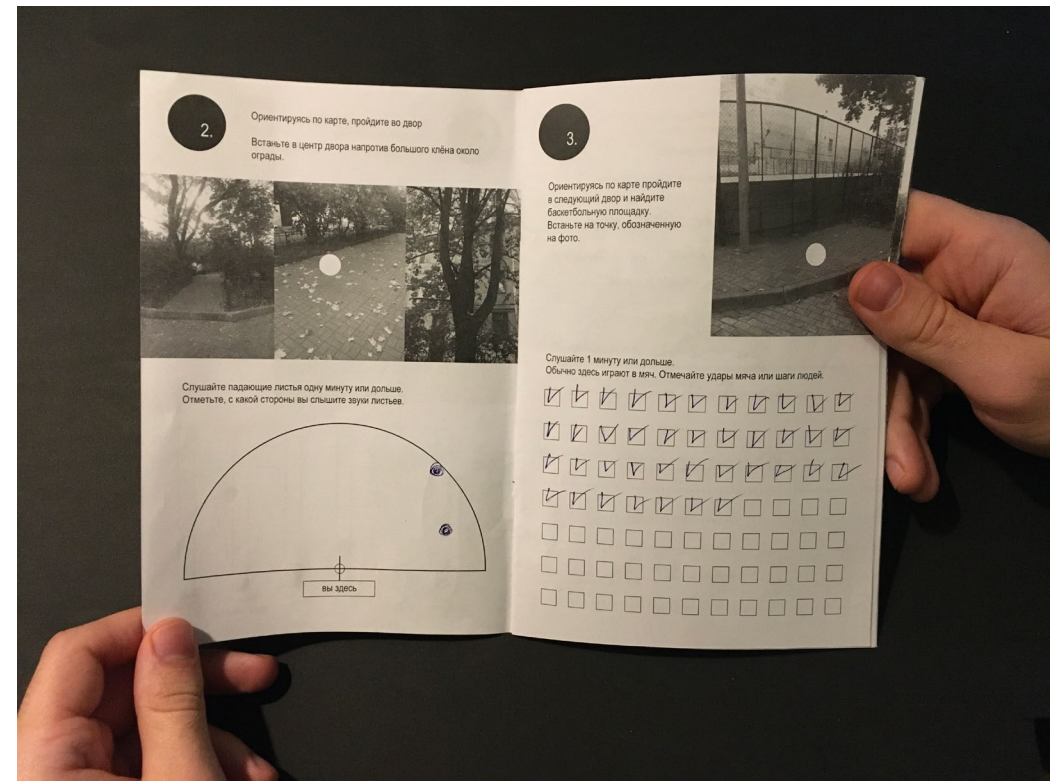
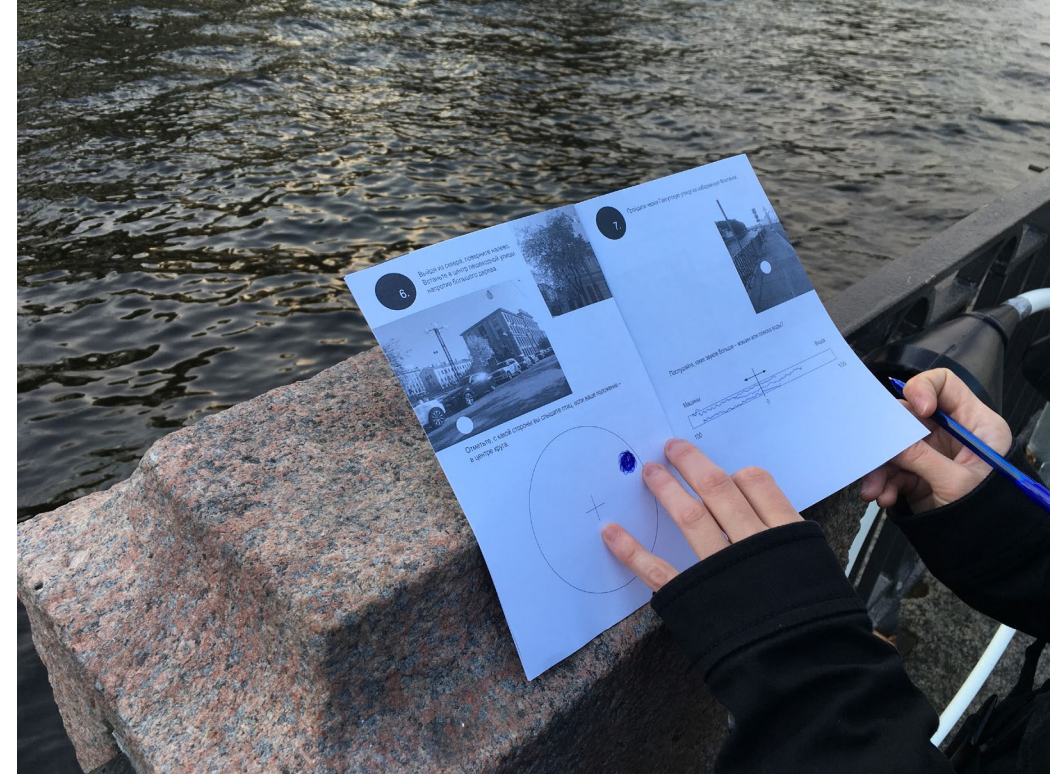



## "Plants", 2020

curators Artur Konstantinov, Natalia Federova, Anna Kozlova, Laura Rodrigues  
For Ars Electronica festival, Pangardenia project, Air gallery, Saint-Petersburg

The artist explores the idea of self-sufficient data, and the possibility of it growing, blossoming and fading away, using fragments of plants belonging to the gallery as her research material. The crucial part of the installation consists of a special algorithm that extracts information from withered plants. The resulting data, multiplying all by itself, grows, blossoms and fades away.

<http://en.annamartynenko.ru/plants.html>

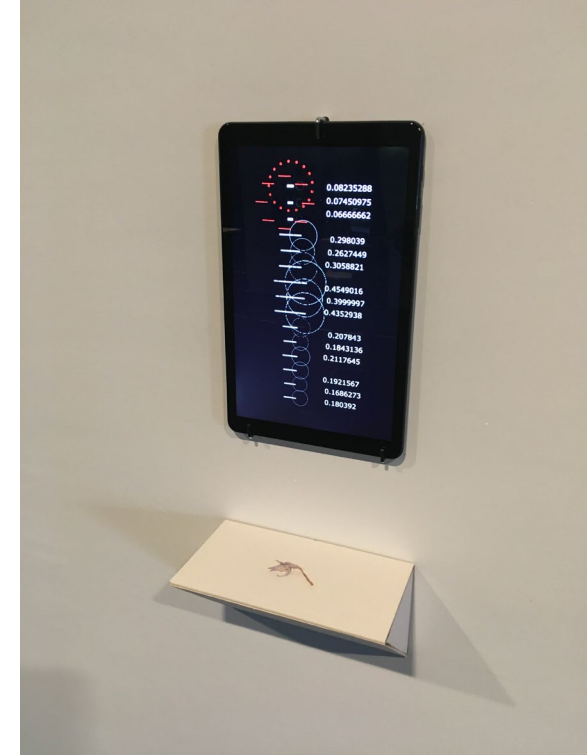



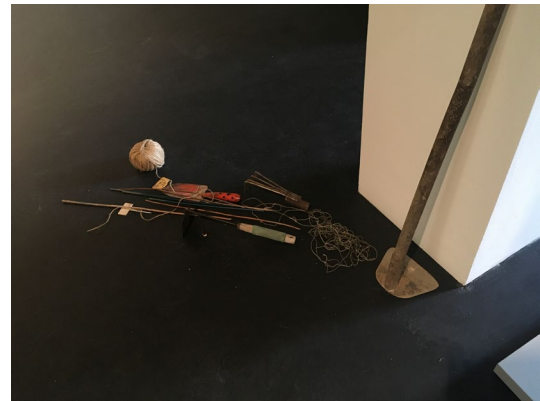



## “Sound Maps”, 2019–2020

21x29,7 cm, thick paper, digital printing, ink

Space wise each map captures the sounds of different places. One can find the coordinates and monitoring hours in the lower left corner of the sheet. The lower right corner indicates four sides as directions for viewing and listening. A certain graphic language has been developed to represent sounds.

<http://en.annamartynenko.ru/sound-maps.html>

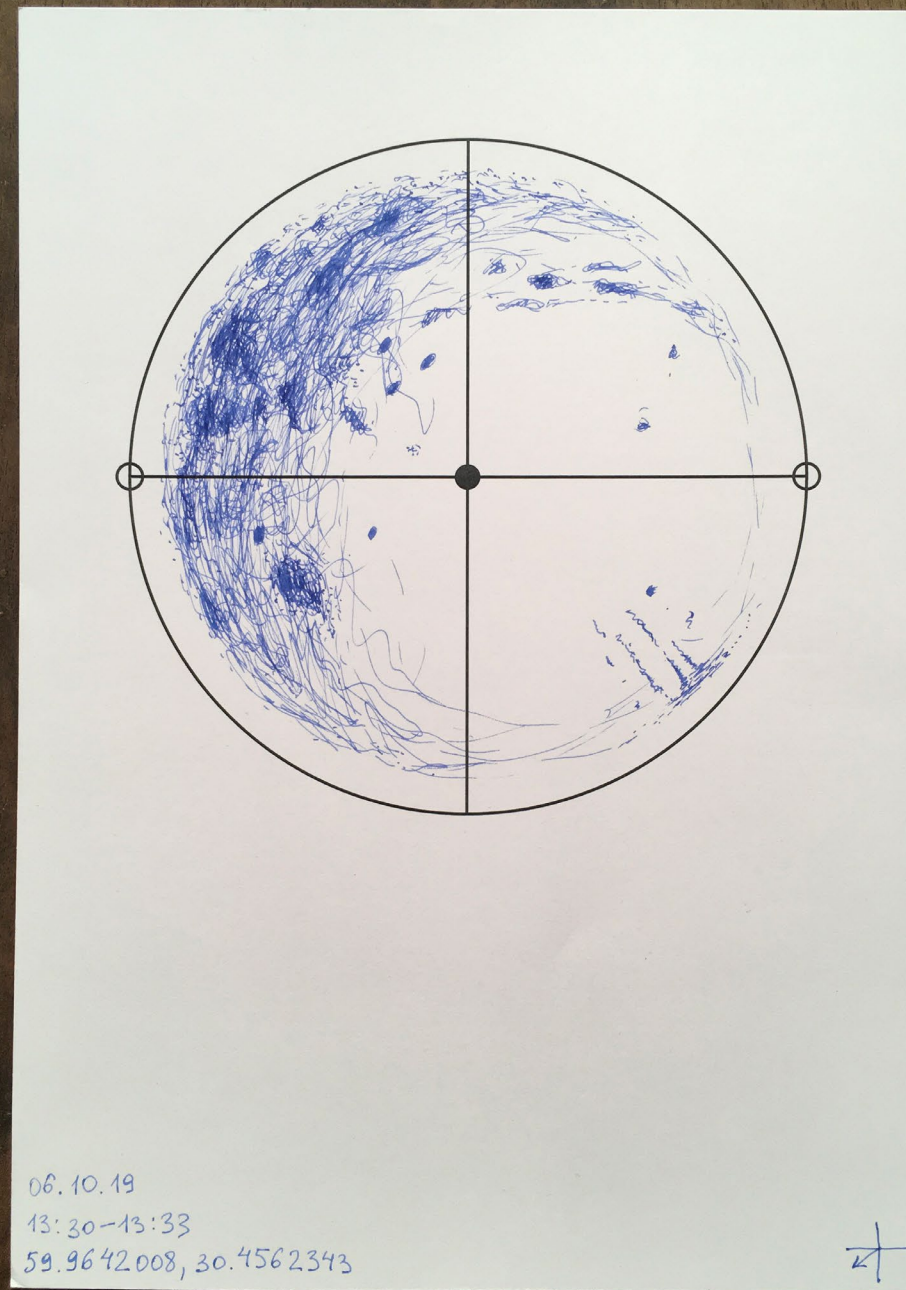
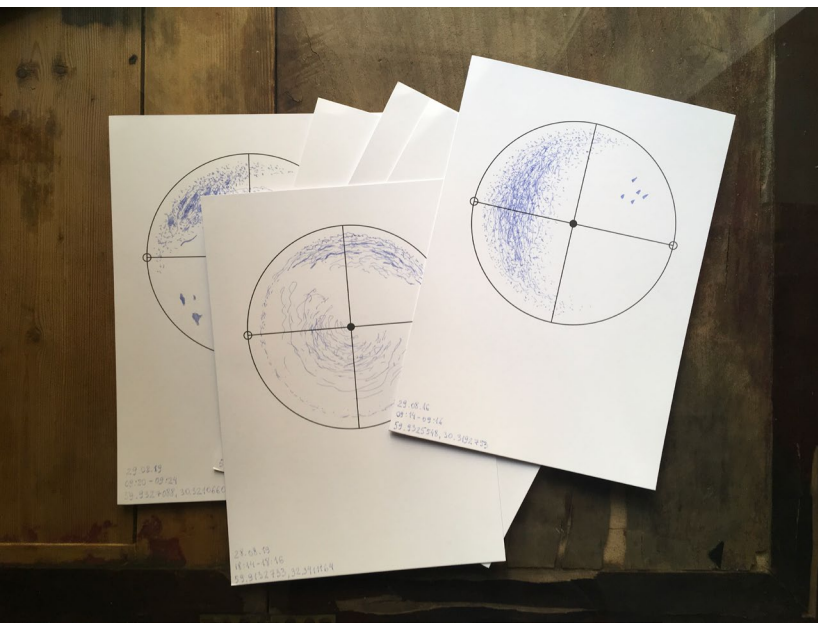



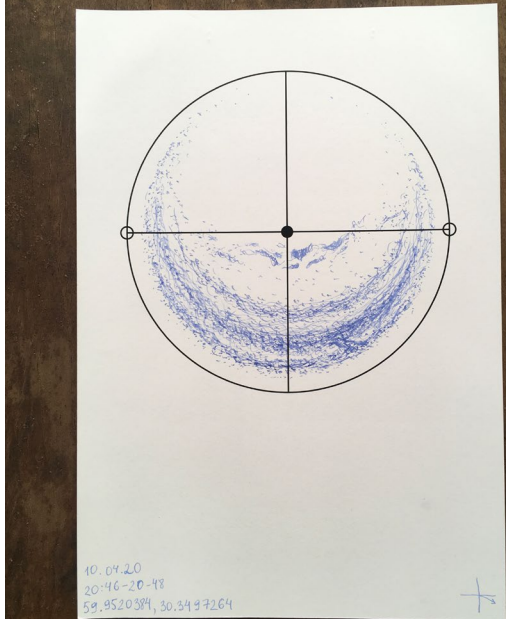
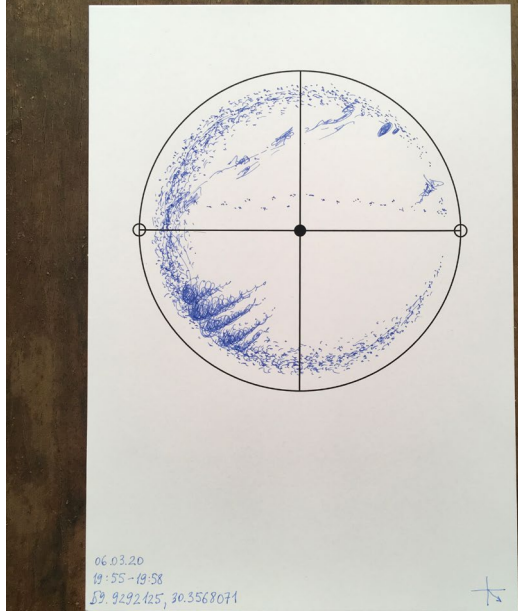
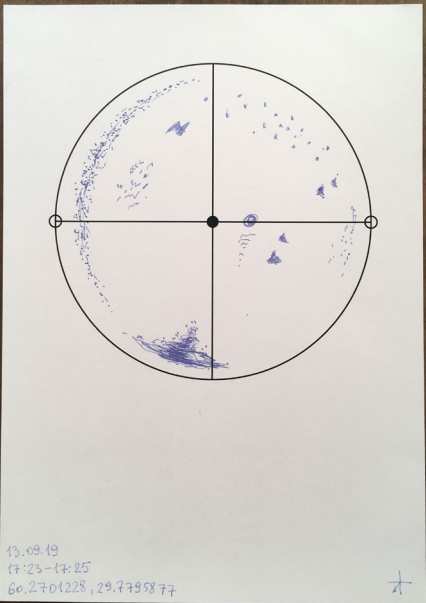
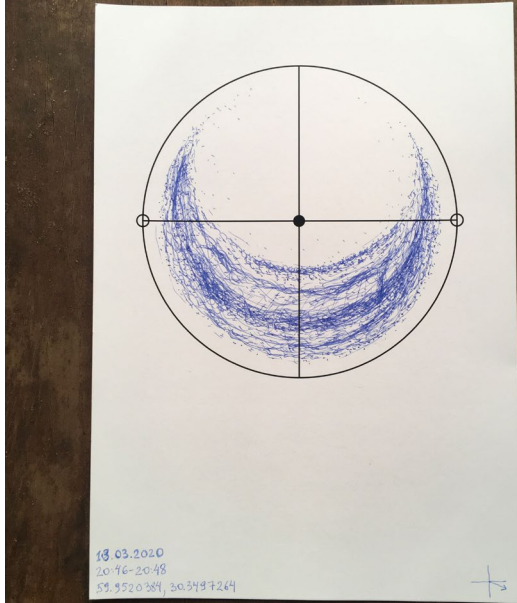
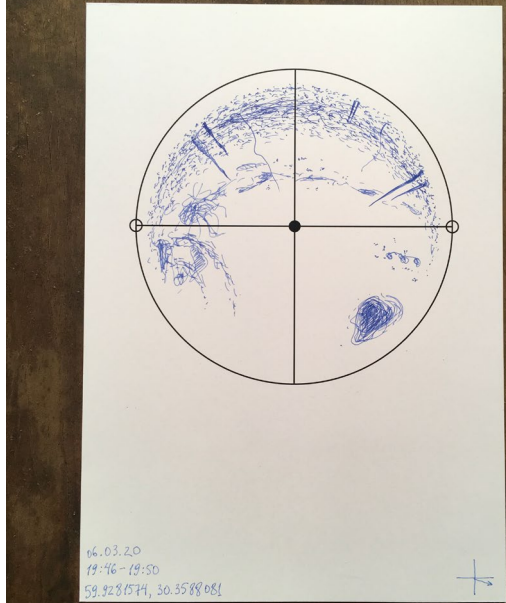
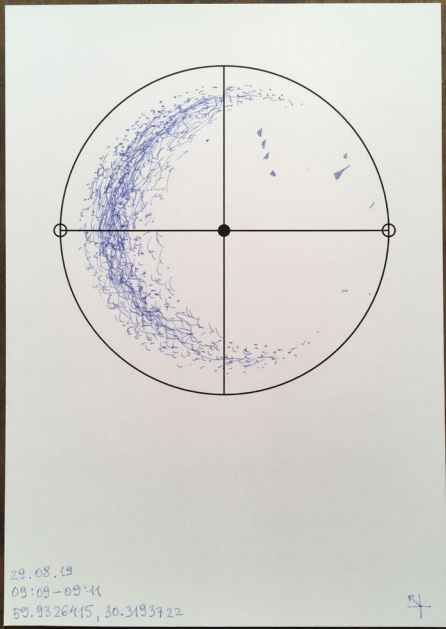



## “Order of Things”, 2019

*Composite panel 30x42cm, direct print, found object, microelectronics*

The project explores the relationship between the physical world and the world of information. Various found objects, used in the work, become sources of information about themselves. Their physical properties, such as their surface area, grayness, number of vertices and dimensions of the sides, are indicated in charts and drawings. Sound also becomes a source of information about the nature of the material. The objects of the analogue world become donors used for the purposes of extracting and expanding information, which becomes something more real than the actual object.

<http://en.annamartynenko.ru/order-of-things.html>

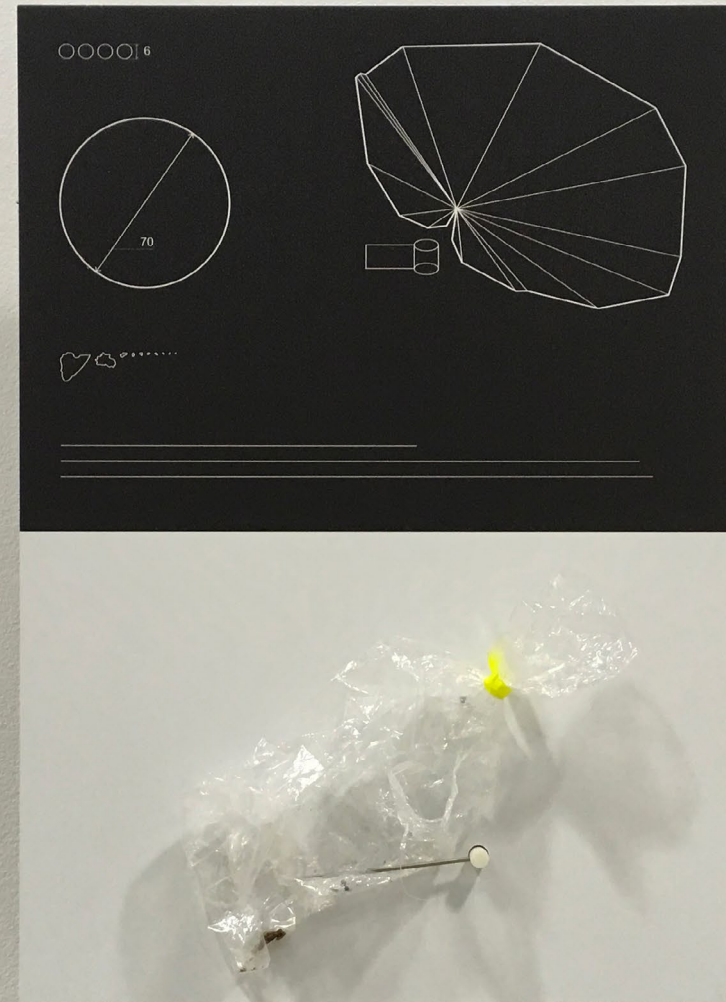

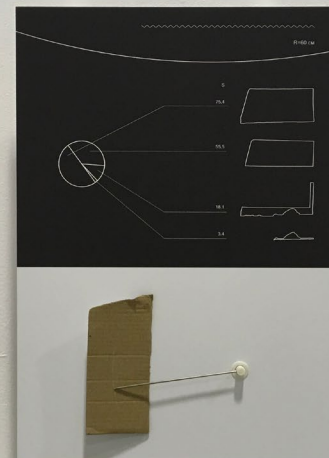
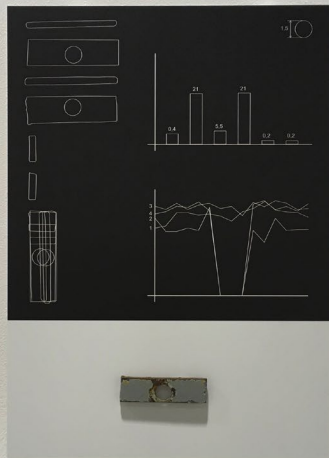
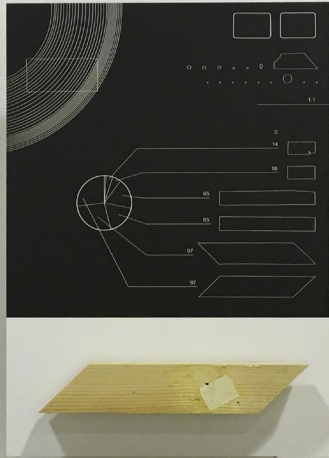

Works of art, created from objects, which were found in a studio of residence "Nepokorennie, 17"



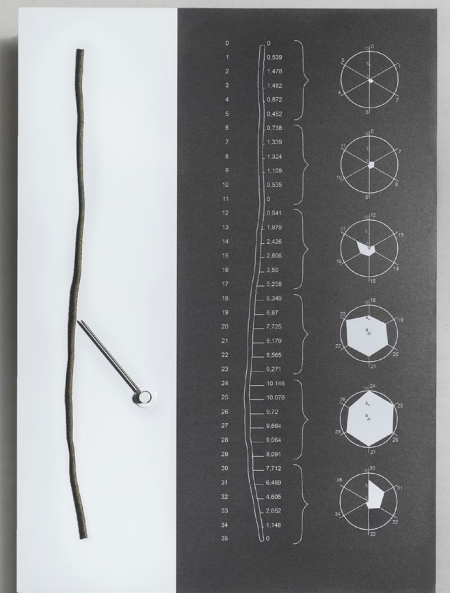
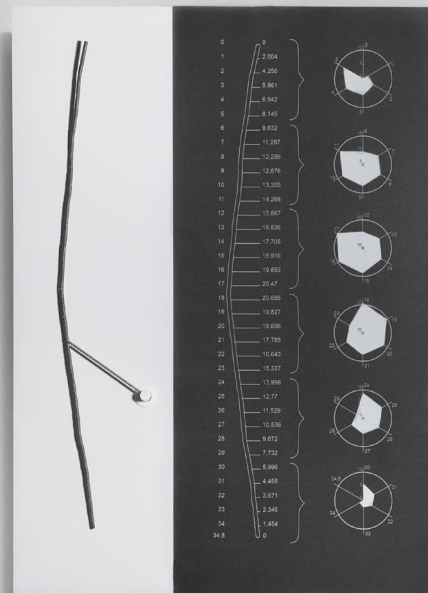
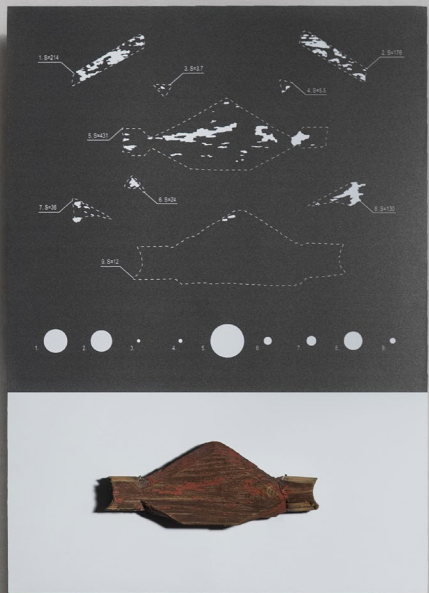
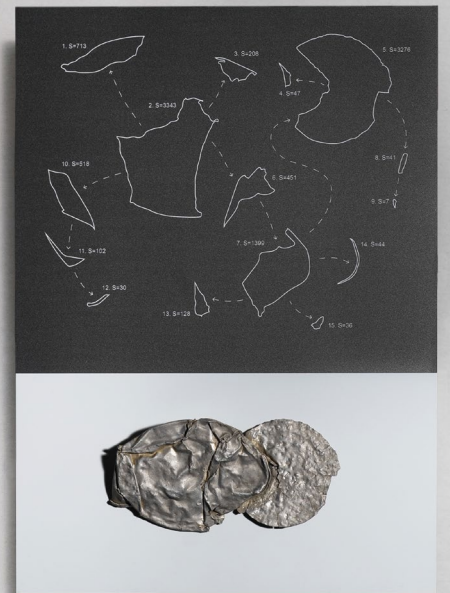
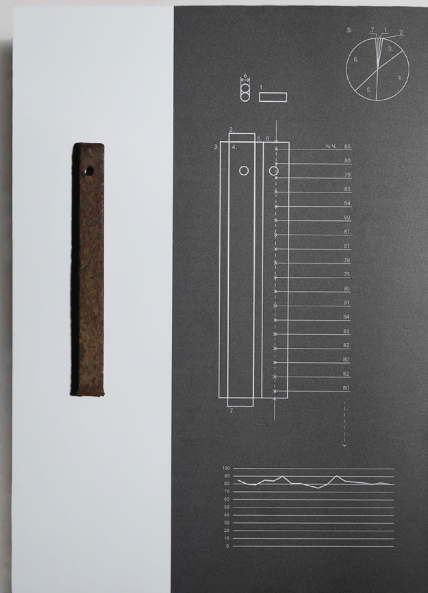
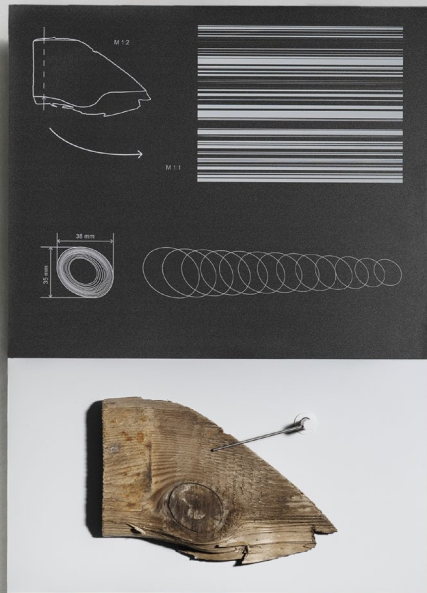
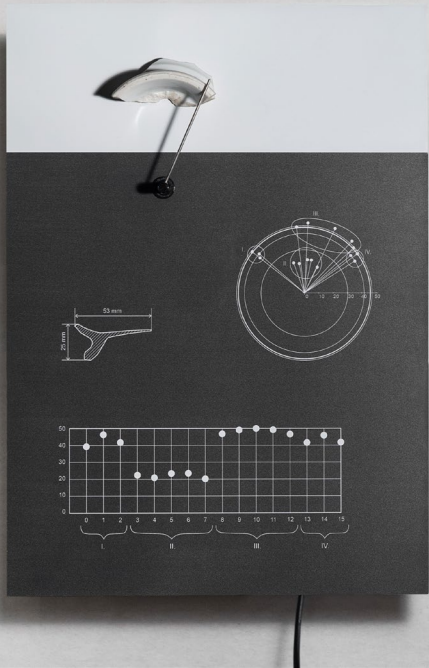

Works of art, created for the exhibition "Contemplators of the sun" from objects, which were found in town Yuryevets





Photo by Alexandra Kokacheva

## “Brick Wall”, 2019

*curator Alexandra Ominina, for the “Ordinary things” exhibition,  
Gromov Palace Of Culture, Saint-Petersburg*

The artist explored one of the walls of the gallery, made of plain brick, by installing solenoid hammers that hit the wall. Each solenoid beats to its own rhythm. Together they form a small orchestra playing on bricks. The strikes of the solenoids are opposed to the “wall of silence” to reinforce the physical presence of the wall.

<http://en.annamartynenko.ru/brick-wall.html>

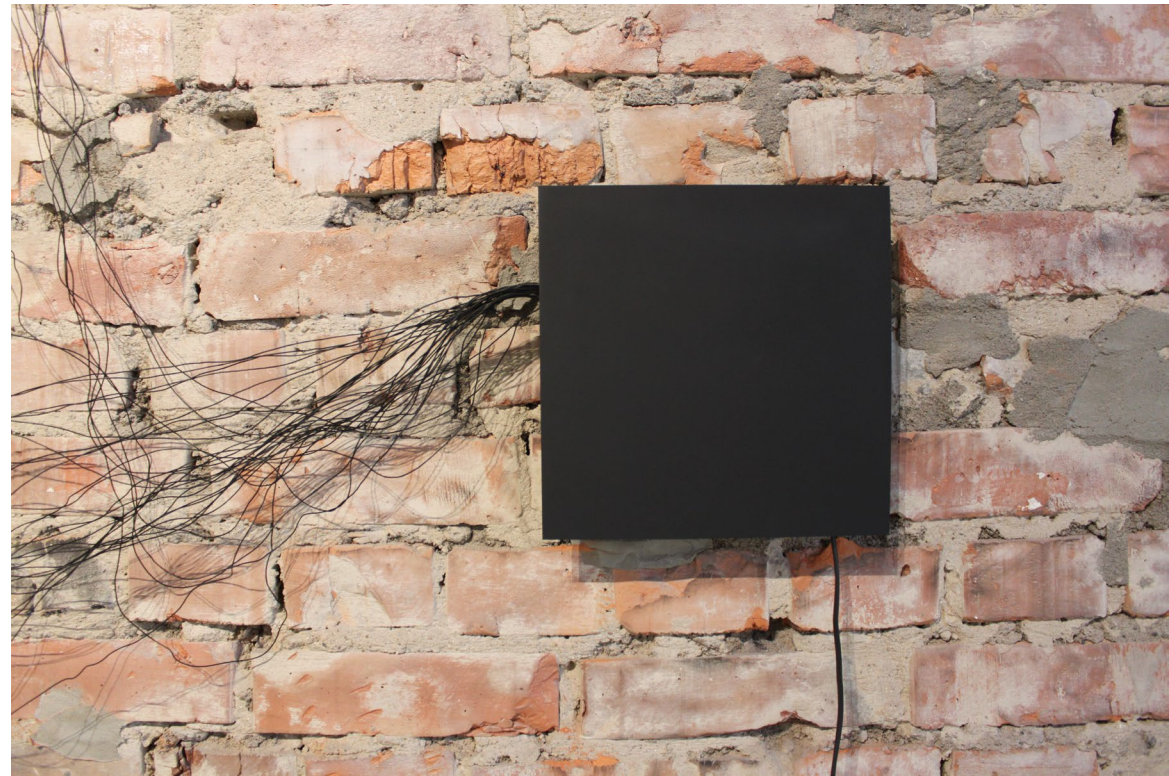







## “Roses of Donbas”, 2019

curator Alexanra Ominina, for “Winter Seedling. Selection of a Breeder”  
Gromov Palace Of Culture, Saint-Petersburg  
110x70x165 cm, steel, electronic components

“Little roses” is a code word for artillery traces and exploded gun barrels. This name unfolds external resemblance to rosebuds in their conical shape and centric composition. This metaphor is literally embodied in the exhibition even if the project is an example of a scientific approach. Little roses grow on metal stems, with their buds shaped as real bombshell traces found in the city of Enakievo, Donetsk region.

<http://en.annamartynenko.ru/roses.html>

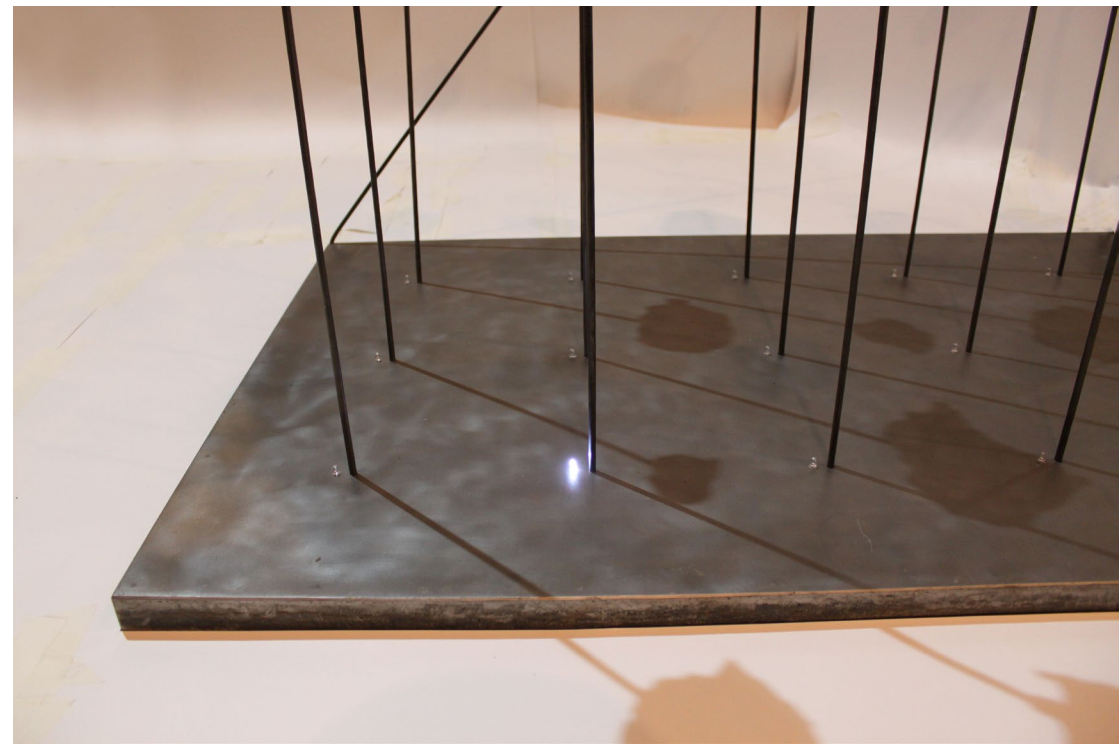
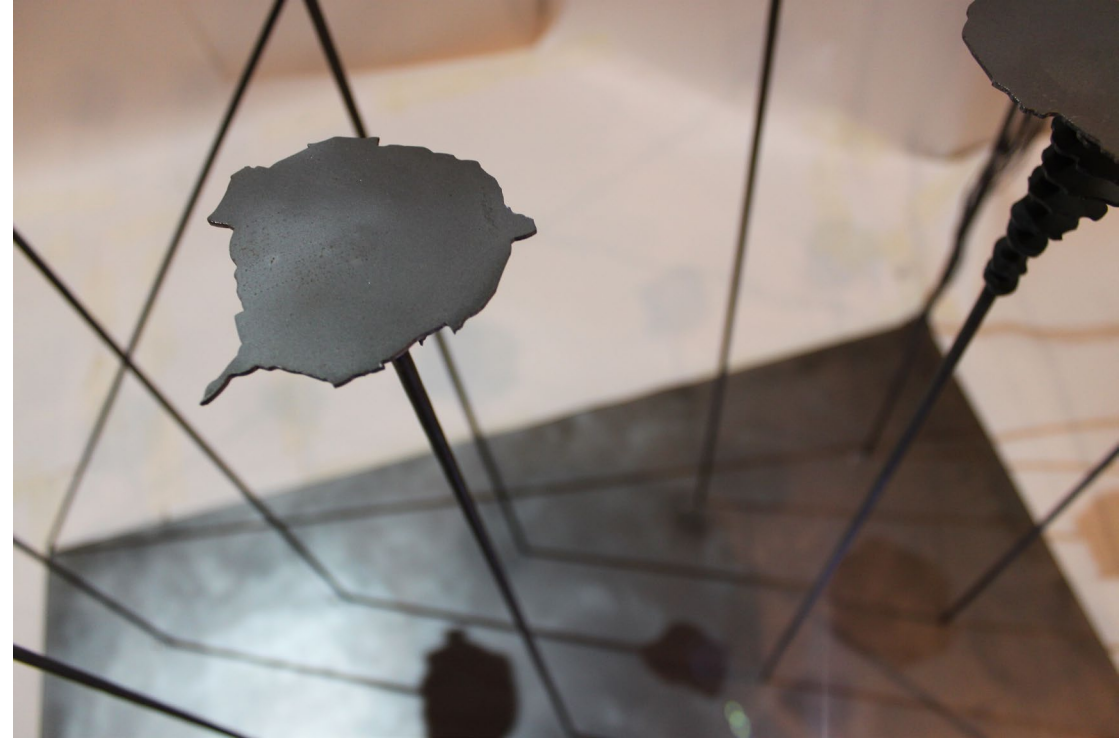



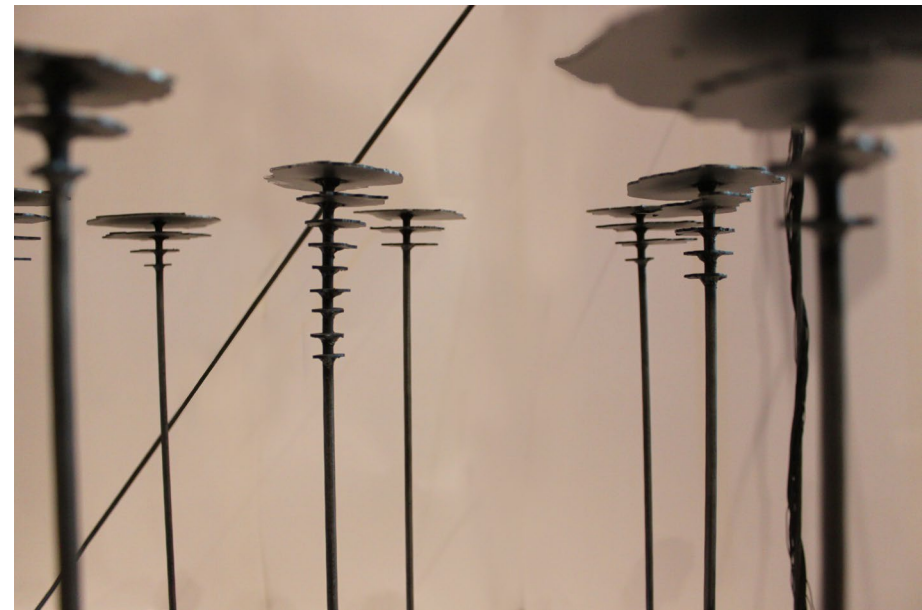



## “Topophones of the City”, 2019

*curator Maria Turkina, near the Alebashevo Lake, Tumen  
plywood, sheet metal*

Topophones are designed to analyze places with sounds, which they amplify according to directions they channel. The background noise, we are used to, becomes distinguishable. We can hear birds singing, people talking, car passing by in the distance, as if they are very close. The three topophones are installed in different places around the lake. The first one is located on a path along the lake, close to the water. It is directed towards the road, capturing sounds of the traffic and the city. The second topophone, the closest to the lake, picks up water sounds the best. The third one channels forest sounds from a place further down the path. Everyone can explore all three topophones and choose a specific soundscape in an opened location.

<http://en.annamartynenko.ru/topophones-of-the-city.html>



*Photoes by Alexandra Kokacheva*







## Light installation “Vocal Tract”, 2018

curator *Katya Bocharov*

For “*Chaliapin AIAT*” – *Artistic Interdisciplinary Anti-Theater*

*Chaliapin Memorial Apartment, Saint-Petersburg*

The project explores a vocal tract as a musical instrument. It is a versatile instrument that has the ability to convey different pitches of sound. To visualize the sound, the artist translates it into the spectrum of light. She adjusts the light using the parameters of light devices so there is a feeling of a sounding light.

The lungs serve as the parameter of the brightness on the diagram, the resonators – as expansion of the beam, the tongue – as stroboscope, etc. The vocal tract illuminates the space. A special alphabet, based on a combination of light and sound parameters, has been created.

Specific Russian phonemes are taken into consideration, and a certain light picture corresponds to each letter of the alphabet. You can set the control knobs to the position indicated in the diagram for a specific letter and see how it sounds.

<http://en.annamartynenko.ru/vocal-tract.html>

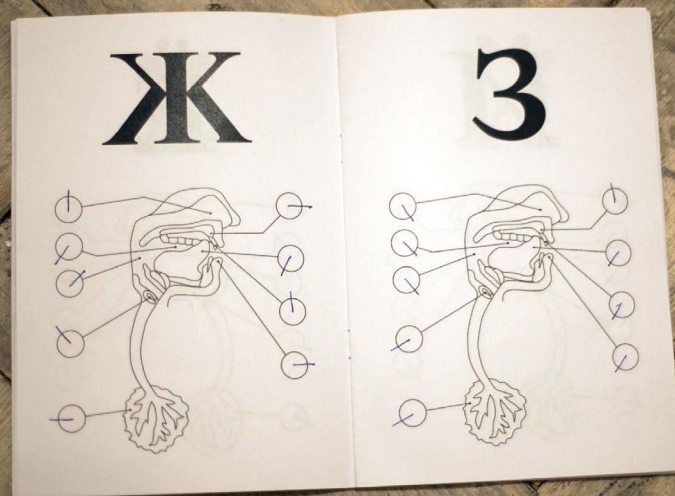
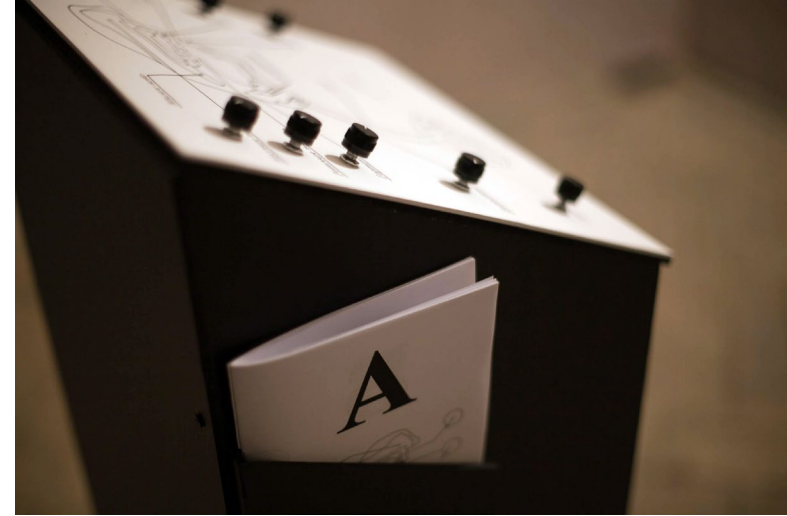





Photo by Ivan Tyshko



## “House of the Wind”, 2017

*for the festival “Light Nights in Gatchina”, Gatchina, Leningrad Oblast*

*Media artist: Anna Martynenko*

*Architects: Natalia Krymskaya, Anastasia Krasikova*

*Sound-design: Daniil Koronkevich, Daniil Grigoriev*

The house is like a simple picture painted with light across a dark park. The wind blows through the frame. The design of the house is controlled by the wind. The house has two wind sensors, one on the ridge beam, the other on one of the vertical beams. The wireframe glows with pulsating lights that can be influenced by visitors. Anyone can blow on the sensor through a special hole and the light lines will begin to overflow and create a light wave.

<http://en.annamartynenko.ru/house-of-wind.html>

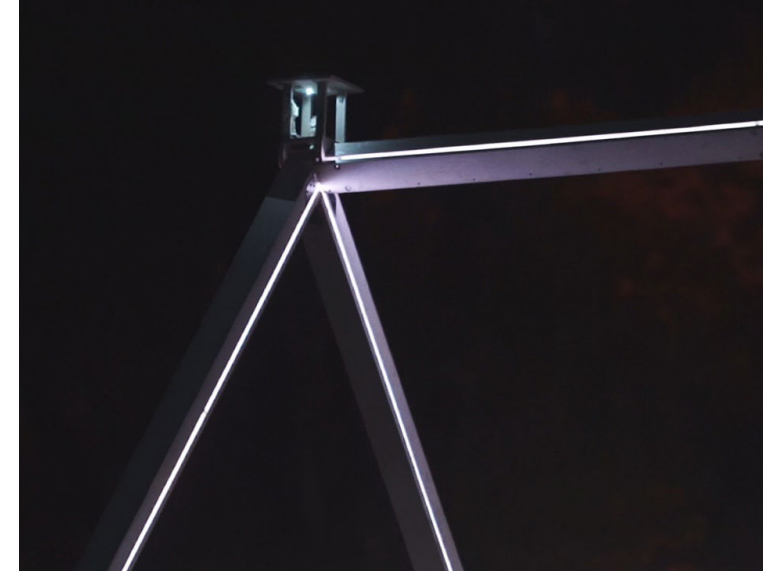







## “Sound“, 2018

*kinetic sound sculpture,  
10x12x3,5 cm, canvas, microelectronic components*

The object examines the properties of a canvas stretched over a frame. A small canvas is primed and stretched in such a way that when it is raised and lowered from behind, the canvas springs back and makes a characteristic sound. The mechanism (solenoid) is installed on the back of the canvas to raise and lower the canvas every 7 seconds. A canvas – a primary attribute of painting – becomes a source of sound.

<http://en.annamartynenko.ru/sound.html>

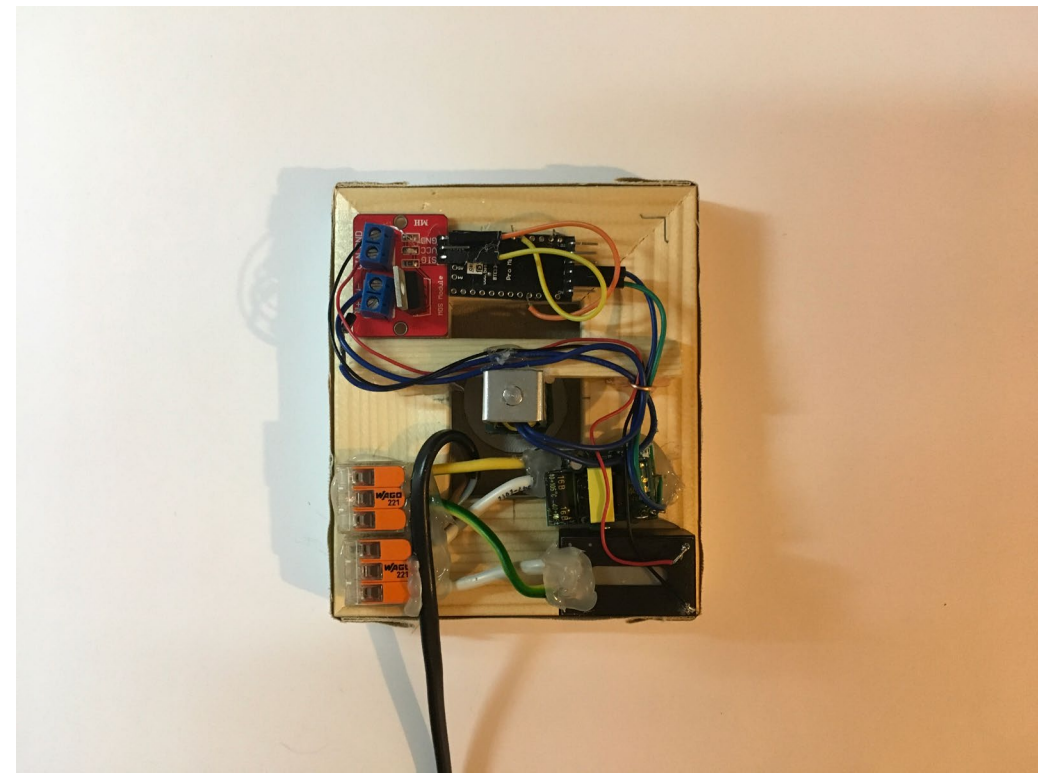



www: [annamartynenko.ru](http://annamartynenko.ru)

E-mail: [annamart22@gmail.com](mailto:annamart22@gmail.com)

Instagram: [@annamart22](https://www.instagram.com/annamart22)

Facebook: [anna.martynenko22](https://www.facebook.com/anna.martynenko22)

Mob.: +79119036942